

SW-2G4G-8A-S is a single pole, eight throw, absorptive switch designed to operate over the 2 to 4GHz frequency range. This model is designed to handle 23dBm max input power. The switch offers fast switching speeds of 50nsec max., low insertion loss of 3.2dB and high isolation of 80dB. The DC supplies are 240mA @ ±5 V.

Mechanical Outline(Unit: Inch):

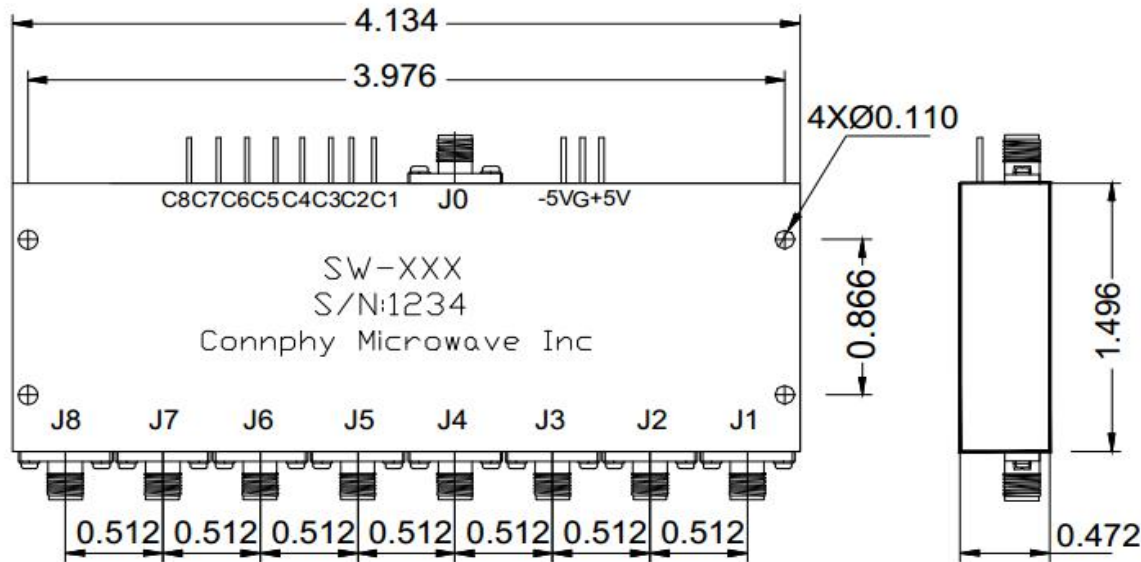

Specifications:

Frequency:	2 to 4GHz
Insertion Loss:	3.2dB max
Isolation:	80dB min
Switching Speed:	50ns max
Power Handling:	23dBm max
VSWR:	1.7:1 max
Voltage/Current:	240mA @ ±5 V typical
Control logic:	TTL
Connectors:	SMA Female
Type:	Absorptive
TTL Truth Table:	Cn=0, Others=1; Path State: J0-Jn

Environmental Ratings:

Temperature:	-25°C to +71 °C Operating -65 °C to +100 °C Non-Operating
Vibration:	MIL-STD-202F, Method 204D Cond. B
Altitude:	MIL-STD-202F, Method 105C Cond. B

Pin Diode Switch SW-2G4G-8A-S			
DRAWN:	DWG NO.:	REV CODE: Rev.1.0	 www.connphy.com sales@connphy.com
CHECKRD:	DATE: 20/05/16	SHEET : 1 OF 1	
ISSUED:	SIZE: A	SCALE : N / A	
			Notes: SPEC ARE SUBJECT TO CHANGE WITHOUT NOTICE.